

OSAWA & COMPANY PRODUCTS CATALOG

● Wonder-Gun is...

a new type of air gun that uses compressed air to blow off, suction, and to transfer materials, and is used widely in many industries.

The products marked  adopt the special jet system, which is a way of bringing out the full power of the compressed air. It works by injecting a large quantity of secondary air in angle to the main air jet and this causes the main air jet to spiral powerfully.

There are no worries that materials get clogged inside of Wonder-gun since it doesn't have any interior restrictions.

★ W101 · W301 Handheld Model

Three in One (Blow off, Suction, Transferring)!!



Recommended Compressor Power
W101.....2.2~3.7kw
W301.....1.1~1.5kw

| Model | Specifications (mm) | | | |
|-------|---------------------|------------|----------------|--------|
| | Length | Minimum ID | Nozzle Orifice | Weight |
| W101 | 144 | φ22 | φ 1.4×6holes | 310g |
| W301 | 142 | φ 11 | φ 1.4×3holes | 260g |

■ We offer powerful version for this model.

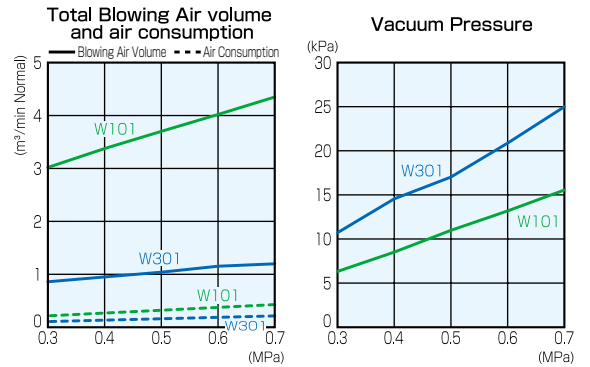

● Suction Nozzle Action

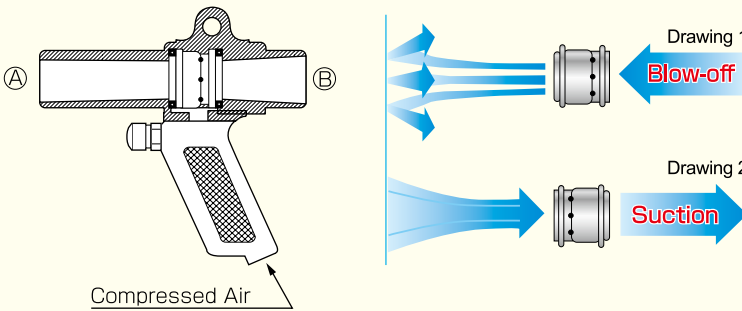

■ For Blow-off

Place the suction nozzle as in the left drawing 1. Then start operation. A large amount of air goes into the gun from side B together with the compressed air, and a strong air flow is blasted in spirals from the holes on the nozzle.

■ For Suction

Place the suction nozzle as in the left drawing 2. Then start operation. A large amount of air goes into the gun from side A together with the compressed air, and a strong air flow is blasted in spirals from the holes on the nozzle. In this operation, Wonder-gun can be used as a cleaner.

■ W101 A set (for suction)

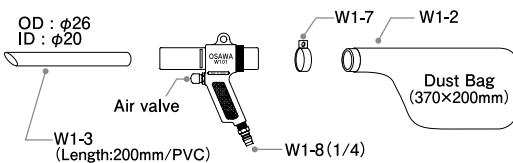

■ W101 B set (for suction)

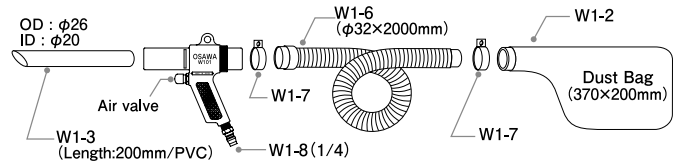

■ W301 A set (for suction)

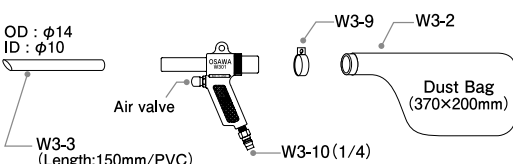

■ W301 B set (for suction)

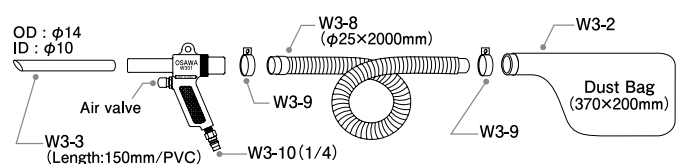

★ W101-III-LC · W101-III-TC · W101-III-LH
W101-III-TH · W101-III (without hose joint)

Mounting Model

W101-III-LC



W101-III-TC



W101-III-LH



W101-III-TH



W101-III
(without hose joint)

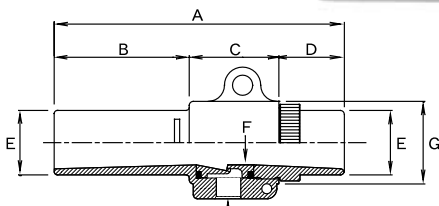

Used Widely in Many Places!!

| Model | A | B | C | D | E | F (Min ID) | G | Nozzle Orifice | Weight |
|----------|-----|----|------|------|---------------|------------|-----|----------------|--------|
| W101-III | 144 | 67 | 44.5 | 32.5 | OD:φ32 ID:φ26 | φ22 | φ41 | φ1.4×6holes | 250g |

■ Please refer to performance chart on page (1).
■ We offer powerful versions.

■ A set (for suction)

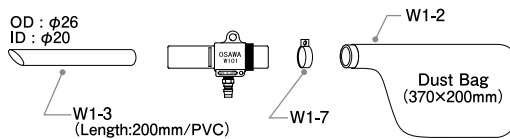

■ B set (for suction)

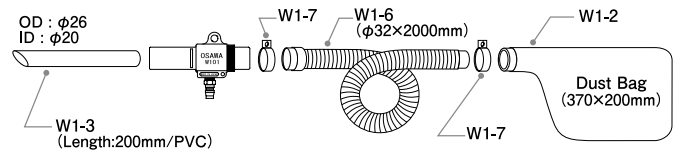

★ W301-III-LC · W301-III-TC · W301-III-LH
W301-III-TH · W301-III (without hose joint)

Mounting Model

W301-III-LC



W301-III-TC



W301-III-LH



W301-III-TH



W301-III
(without hose joint)

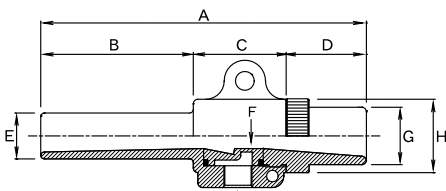

| Model | A | B | C | D | E | F (Min ID) | G | H | Nozzle Orifice | Weight |
|----------|-----|------|------|----|---------------|------------|---------------|-----|----------------|--------|
| W301-III | 142 | 66.5 | 40.5 | 35 | OD:φ20 ID:φ14 | φ11 | OD:φ25 ID:φ18 | φ32 | φ1.4×3holes | 175g |

■ Please refer to performance chart on page (1).
■ We offer powerful versions.

■ A set (for suction)

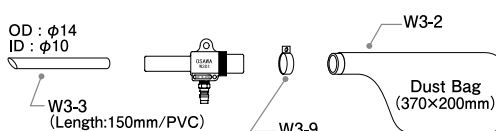

■ B set (for suction)

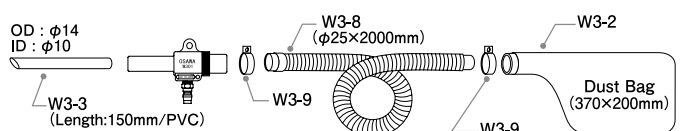

☆ J-38 · J-50 · J-75

Jumbo Model



Recommended Compressor Power
J-38...7.5~11kw
J-50...15~18.5kw
J-75...More than 26kw

Simple Structure!!
 Mounting Model !!

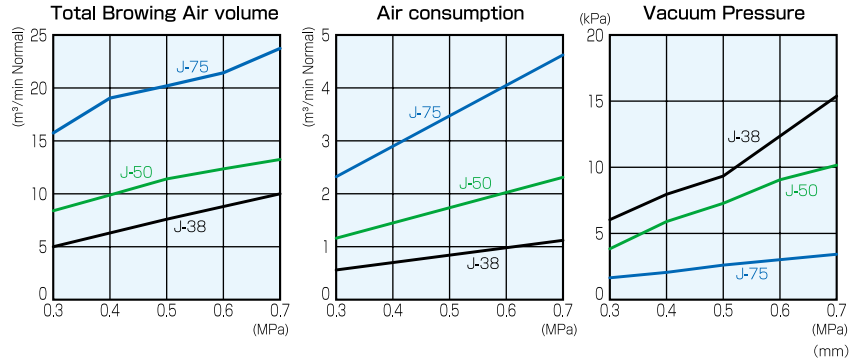
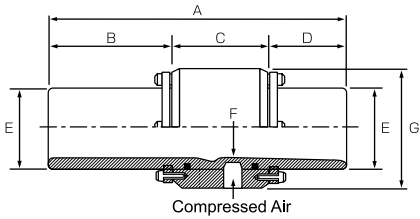

| Model | A | B | C | D | E | F(Min ID) | G | Nozzle Orifice | Weight | Ball Valve | Air Connection | Mounting Holes |
|-------|-----|-----|----|----|-----|-----------|------|----------------|--------|------------|----------------|----------------|
| J-38 | 190 | 80 | 60 | 50 | φ50 | φ38 | φ 75 | φ1.6×12holes | 1.8kg | 3/8 | 1/2" | M8×6 |
| J-50 | 219 | 90 | 66 | 63 | φ63 | φ50 | φ 90 | φ2.3×12holes | 2.5kg | 3/8 | 1/2" | M8×6 |
| J-75 | 270 | 120 | 76 | 74 | φ90 | φ75 | φ115 | φ2.3×24holes | 4.0kg | 1/2 | 3/4" | M8×6 |

■ Because of small lot of production, Jumbo model becomes out of stock. ■ We offer powerful versions of Jumbo model.
 ■ We offer hoses and dust bag specially for Jumbo model.

☆ W501-S · NW501-S · W501-SG · NW501-SG W501-L · NW501-L · W501-LG · NW501-LG

Mini Model

Compact!! Mounting Model !!

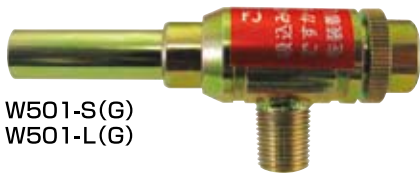

W501-S(G)
 W501-L(G)



NW501-S(G)
 NW501-L(G)

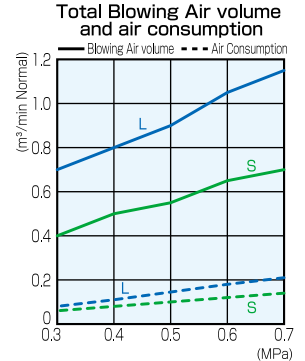
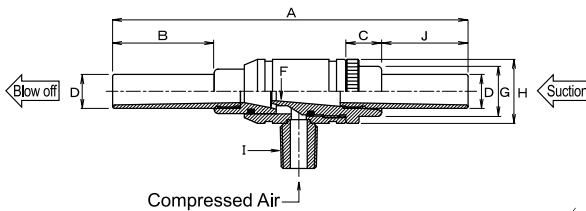
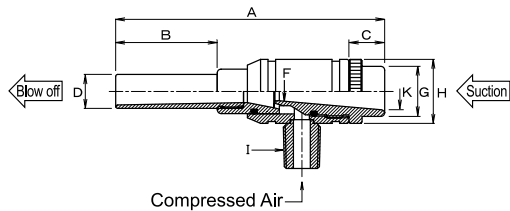

| Model | A | B | C | D | F(Min ID) | G | H | I | J | K | Nozzle Orifice | Weight |
|------------|------|----|------|---------------|-----------|-------|-----|-----|----|-----|--------------------------|--------|
| W501-S(G) | 71.5 | 27 | 10.5 | OD:φ 9 ID:φ 7 | φ5 | φ13.3 | φ17 | 1/8 | — | φ10 | φ1.2×3holes(φ1.2×6holes) | 58g |
| W501-L(G) | 71.5 | 27 | 10.5 | OD:φ12 ID:φ10 | φ8 | φ16.3 | φ21 | 1/8 | — | φ13 | φ1.3×3holes(φ1.3×6holes) | 80g |
| NW501-S(G) | 94.5 | 27 | 10.5 | OD:φ 9 ID:φ 7 | φ5 | φ13.3 | φ17 | 1/8 | 23 | — | φ1.2×3holes(φ1.2×6holes) | 60g |
| NW501-L(G) | 94.5 | 27 | 10.5 | OD:φ12 ID:φ10 | φ8 | φ16.3 | φ21 | 1/8 | 23 | — | φ1.3×3holes(φ1.3×6holes) | 83g |

■ Powerful versions: Total air blast and thrust increase 70% and suction force increases 50%.

■ B set (for suction)

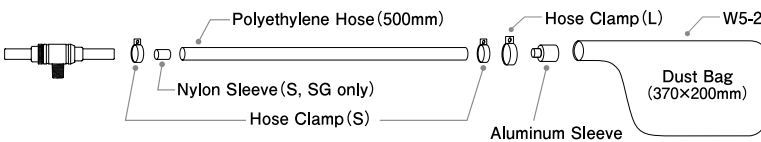

Recommended Compressor Power
W501-S(L)..... 1.1~1.5kw
W501-SG(LG)..... 1.5~3kw
NW501-S(L)..... 1.1~1.5kw
NW501-SG(LG).... 1.5~3kw

☆ YW501-SG · YW501-LG

YW501 Model



For Suction



For Blow-off

Recommended Compressor Power
1.5~3kw

YW501 series are equipped with hand-grips. Please make sure to specify either suction or blow-off.

■ Please confirm delivery schedule since YW501 type are custom-ordered products.

★ W101-YZ

Wide-Catch Model

Draws in and Blow off At the Same Time. How Clever!

Plenty of Uses...

- Cleaning inside of wide-mouth bottles!
- Cleaning food containers!
- Removing chips from holes!



W101-YZ

Features:

Air Blow Nozzle blows off materials and a Wide-mouth suction pipe never fails to catch them.

- * Wonder-Gun Wide Catch model is provided as the unit below.
- Please order "W101-YZ Gun only" when you require only the gun.
- * It can be used with Dust Collector PC-1 or W1-20.

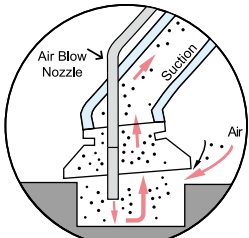

Don't seal completely!!
Requires outside air intake to work effectively.

■ Wonder-Gun Wide Catch model is provided as the unit below.

Unit contains:

- Wide-Catch Model ————— 1
- $\phi 32$ Duct Hose(2m) ————— 1
- Dust Bag ————— 1
- Hose Clamp ————— 2

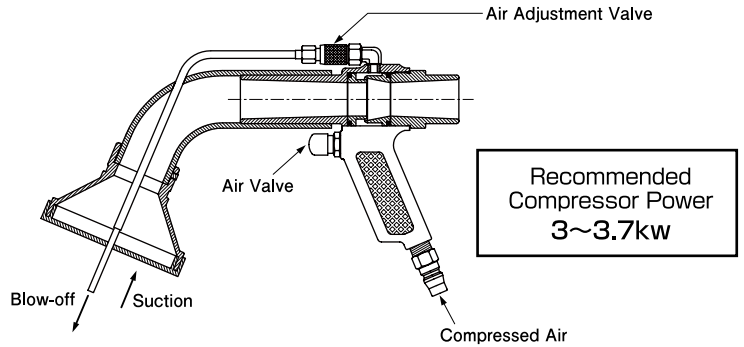

Recommended Compressor Power
3~3.7kw

| Model | Specifications (mm) | | | | | |
|---------|---------------------|--------|-----------------------------|--------------------|-------------------|---------------------------|
| | Length | Weight | Wide-mouth metal fitting | Air Blow Nozzle OD | Suction Nozzle ID | Nozzle Orifice |
| W101-YZ | 281 | 600g | OD: $\phi 98$ ID: $\phi 85$ | $\phi 4$ | $\phi 22$ | $\phi 1.4 \times 6$ holes |

■ Unit contains

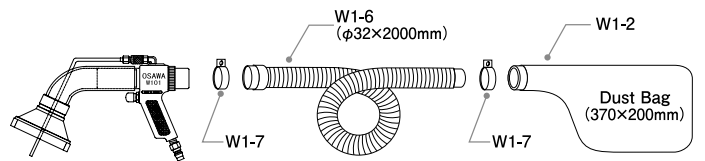

★ W101-YZ-LC · W101-YZ-TC · W101-YZ-LH W101-YZ-TH · W101-YZ (without hose joint)

Mounting Model



W101-YZ-LC



W101-YZ-TC



W101-YZ-LH

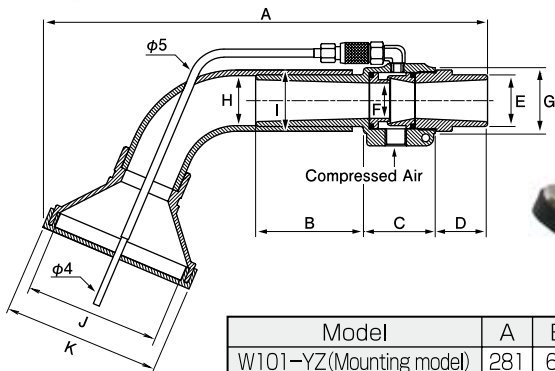

W101-YZ-TH



W101-YZ (without hose joint)

| Model | A | B | C | D | E | F (Min ID) | G | H | I | J | K | Nozzle Orifice |
|--------------------------|-----|----|------|------|-----------------------------|------------|-----------|-----------|-----------|-----------|-----------|---------------------------|
| W101-YZ (Mounting model) | 281 | 67 | 44.5 | 32.5 | OD: $\phi 32$ ID: $\phi 26$ | $\phi 22$ | $\phi 41$ | $\phi 31$ | $\phi 39$ | $\phi 85$ | $\phi 98$ | $\phi 1.4 \times 6$ holes |

■ A set

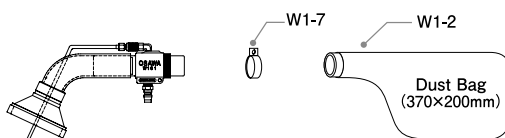

■ B set

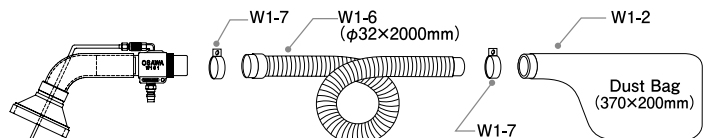

Wide-Catch Mounting Model is not a set; If you wish, please specify A or B at the end of the model number.

☆ W101-II Hole Cleaning model



W101-II

● Wonder-Gun Hole Cleaning model can be used with Dust Collector PC-1 or W1-20.

How It Works:

Put Air Blow Nozzle into a hole and then press Air Valve. Air comes out from the nozzle, and blow dust off. The dust is cleaned by the Transparent pipe.

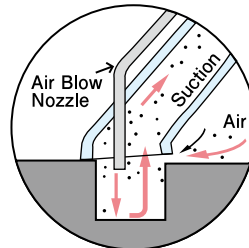
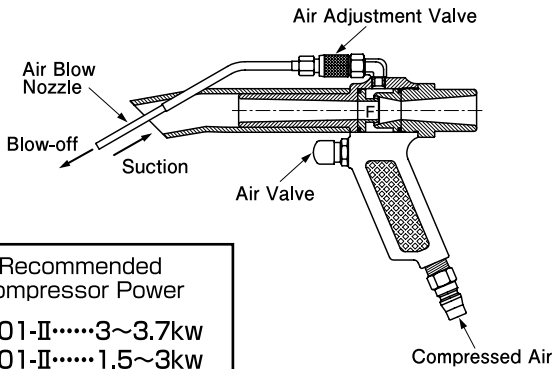

Don't seal completely!!
Requires outside air intake to work effectively.

Recommended Compressor Power
W101-II.....3~3.7kw
W301-II.....1.5~3kw

| Model | Specification (mm) | | | | | |
|---------|--------------------|--------|---------------|--------------------|---------------------------|----------------|
| | Length | Weight | Suction Pipe | Air Blow Nozzle OD | Suction Nozzle Min. ID(F) | Nozzle Orifice |
| W101-II | 235 | 435g | OD:φ39 ID:φ31 | φ5 | φ22 | φ1.4×6穴 |
| W101-II | 210 | 350g | OD:φ26 ID:φ20 | φ4 | φ11 | φ1.4×3穴 |

☆ W301-II Hole Cleaning model



W301-II

● Wonder-Gun Hole Cleaning model can be used with Dust Collector PC-3 or W3-20.

■ Wonder-Gun Hole Cleaning model is provided as the unit below.

Unit contains:

- Hole Cleaning Model ——— 1
- Duct Hose(2m) ——— 1
- Dust Bag ——— 1
- Hose Clamp ——— 2

- Cleans dust or chips in holes efficiently!!
- Demonstrates great power in tapping!!

Unit contains

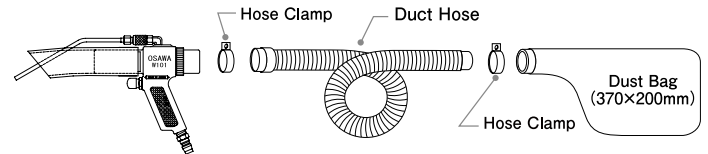

☆ W101-II-LC · W101-II-TC · W101-II-LH W101-II-TH · W101-II(without hose joint) Hole Cleaning Mounting model

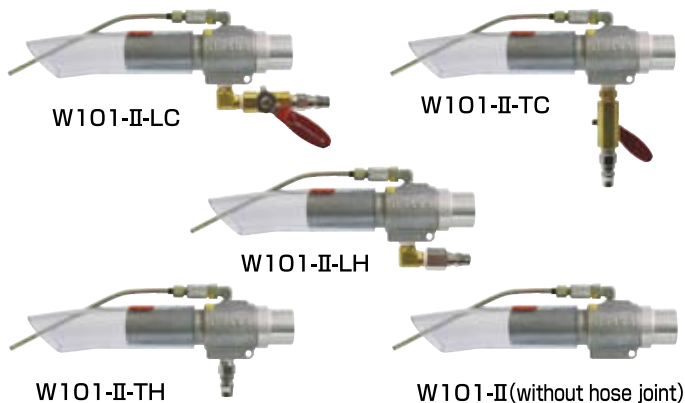

☆ W301-II-LC · W301-II-TC · W301-II-LH W301-II-TH · W301-II(without hose joint) Hole Cleaning Mounting model

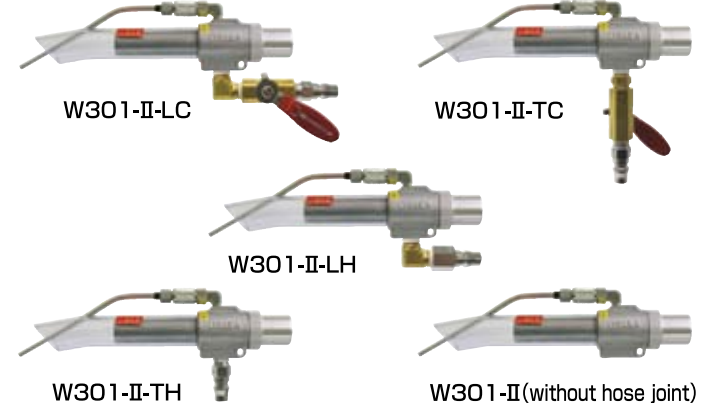

■ A set

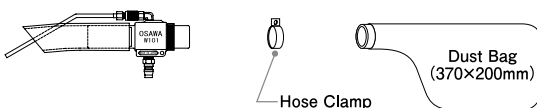

■ B set

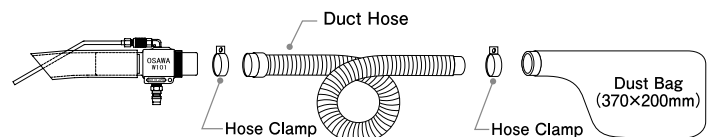

Hole Cleaning Mounting model is not a set; If you wish, please specify A or B at the end of the model number.

★ W701

Pencil Model



Small Size!!
Use as tweezers or for
Cleaning in corners!!

Feature

1. Compact and fits in your hand.
2. Can be used with low-pressure compressed air (0.15~0.5MPa), thus safe and doesn't need much compressed air.
3. Suction pipe can be easily replaced for other uses.
4. There are no worries that materials will get clogged inside of Wonder-Gun due to a smooth walled interior construction.

| Specification (mm) | | | |
|--------------------|------|-----|--------|
| Length | ID | OD | weight |
| 137 | φ2.8 | φ20 | 60g |

Recommended Compressor Power
0.75kw

■ W701 pencil model is provided as the unit below.

Unit contains:

- Pencil Model _____ 1
- 6×4 Air Tube 1.4m _____ 1
(Equipped with 1/4" hose joint)
- 8×5 Tube for dust bag 0.4m _____ 1
- Injection needle nozzle _____ 1
- Dust Bag for W701 _____ 5

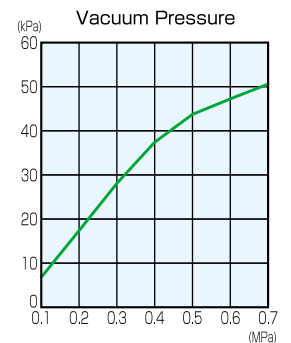

FV-10

Air Foot Valve



| Length | Width | Height | Weight | Hose Joint |
|--------|-------|--------|--------|------------|
| 170 | 82 | 58 | 480g | 1/4" |

For Easy Pedal Operation!!

1 Strong Enough for Daily Use.

This product is made of aluminum die casting.

2 Easy Operation.

Use both hands free; Can be used with foot.

3 Simple Construction.

Air passes through smoothly so there are no breakdowns.

Air Foot Valve can be connected to W101 and W301 mounting model, W501 series, W701, and other air tools as well.

W301-ES-22 · W301-ES-26

Air Blast Model

Easily remove rust, scale and paint from parts and small equipment, leaving a satin finish ready for paint or further preparation. Air blast type sprays most abrasives including glass beads, aluminum oxide, steel grit, or liquids like oil. Draws abrasives straight from bucket or bag.

■ W301-ES-22 Weight 406g SK Jet Nozzle ID φ6

| Air Pressure MPa | Discharge per minute | | Vacuum Pressure kPa | Air Consumption ℓ/min Normal |
|------------------|----------------------|--------|---------------------|------------------------------|
| | Sand | Water | | |
| 0.4 | 800g | 1000cc | 57.6 | 234 |
| 0.5 | 850g | 800cc | 55.3 | 280 |
| 0.6 | 850g | 700cc | 49.7 | 327 |
| 0.7 | 850g | 550cc | 41.8 | 373 |

■ W301-ES-26 Weight 440g SK Jet Nozzle ID φ8

| Air Pressure MPa | Discharge per minute | | Vacuum Pressure kPa | Air Consumption ℓ/min Normal |
|------------------|----------------------|--------|---------------------|------------------------------|
| | Sand | Water | | |
| 0.4 | 1800g | 1800cc | 56.5 | 462 |
| 0.5 | 1800g | 1650cc | 58.4 | 554 |
| 0.6 | 2000g | 1500cc | 57.5 | 646 |
| 0.7 | 2000g | 1400cc | 53.8 | 738 |

■ We offer a powerful version of air blast gun (W301-ES-28 with Jet Nozzle ID φ10). Please contact us for detail.

■ W301-ES air blast model is provided as the unit below.

Recommended Compressor Power

W301-ES-22.....1.5~3kw
 W301-ES-26.....3~5.5kw

Unit contains:

- Air Blast Model _____ 1
- Suction Hose (2m) _____ 1
- Suction Pipe (Iron) _____ 1

Powerful Injection!!

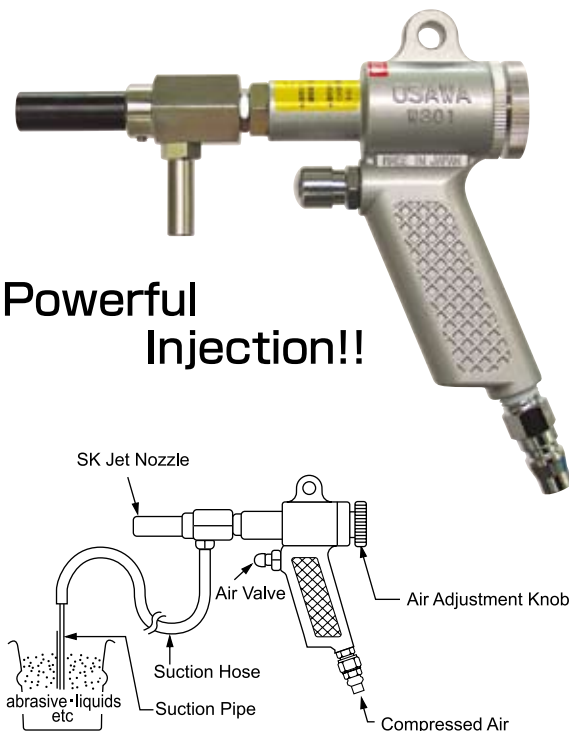

※ This can be remodeled to mounting model. Please refer to mounting model on page (2).

☆ W1-20 · W1-20SET
W3-20 · W3-20SET

Dust Collector
Dust Collector Set



Dust Collector
W1-20 (Weight : 6.7kg)

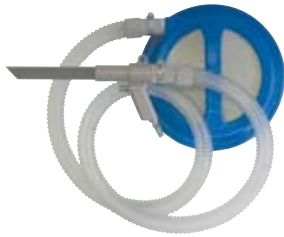

Dust Collector Set
W1-20SET (Weight : 7.7kg)



Dust Collector
W3-20 (Weight : 6.7kg)



Dust Collector Set
W3-20SET (Weight : 7.4kg)

Unit Contains:

| Model | Wonder-Gun | Suction Pipe | Hose(Oil Resistance) | Hose Clamp | Dust Collector | Air coupler |
|-----------|------------|------------------|----------------------|------------|--------------------|-------------|
| W1-20 Set | W101 1PC | φ20×200mm 1PC | φ32×2000mm 1PC | 2PCS | W1-20(φ300) 1PC | 1/4 1PC |
| W3-20 Set | W301 1PC | φ10×150mm 1PC | φ25×2000mm 1PC | 2PCS | W3-20(φ300) 1PC | 1/4 1PC |

※The above products don't include any tanks.

Easy to Use!! For a Wide Range of Application!

- W1-20 set and W3-20set series can be combined with 20ℓ tank. You can collect the materials which have been vacuumed by Wonder-Gun.
- W1-20 can be combined with Wonder-Gun W101 series mounting model, Wide-Catch model, and Hole Cleaning model.
- W3-20 can be combined with Wonder-Gun W301 series mounting model, and Hole Cleaning model.
- We offer replacement filters.

Wonder-Gun Dust Collector series don't fit to handle liquid and powders. Please use Silent Cleaner or Mini Porter Cyclone for liquids and powders.

■ Please refer to page(1) for performance chart.

☆ PC-1 · PCS-1
PC-3 · PCS-3

Dust Filter
Dust Collector Super



Dust Filter
PC-1 (Weight : 6.5kg)



Dust Collector Super
PCS-1 (Weight : 7.7kg)



Dust Filter
PC-3 (Weight : 6.5kg)



Dust Collector Super
PCS-3 (Weight : 7.4kg)

Unit Contains:

| Model | Wonder-Gun | Suction Pipe | Hose(Oil Resistance) | Hose Clamp | Dust Collector | Air coupler |
|-------|------------|------------------|----------------------|------------|----------------|-------------|
| PCS-1 | W101 1PC | φ20×400mm 1PC | φ32×2000mm 1PC | 2PCS | PC-1 | 1/4 1PC |
| PCS-3 | W301 1PC | φ10×300mm 1PC | φ25×2000mm 1PC | 2PCS | PC-3 | 1/4 1PC |

Easy to Move!! For a Wide Range of Application!

- Equipped with a 20ℓ tank and aluminum stand with casters. Easy to move.
- PCS-1 can be combined with Wonder-Gun W101 series mounting model, Wide-Catch model, and Hole Cleaning model.
- PCS-3 can be combined with Wonder-Gun W301 series mounting model, and Hole Cleaning model.
- We offer replacement filters.

Wonder-Gun Dust Collector series don't fit to handle liquids and powders. Please use Silent Cleaner or Mini Porter Cyclone for liquids and powders.

■ Please refer to page(1) for performance chart.

★ SC60-32S · SC60-38S (for Dust Collection)
 SC60-32S W/F · SC60-38S W/F (for Fine Dust Collection)

POWERFUL & SILENT

Silent Cleaner can handle water, oil, sludge, gravel, grain, metal chips and many more materials than other existing vacuum cleaners

★Removable!!
 ★Built-in Silencer!!

★Use for Hours of Continuous Operations!!



Operating Noise 0.5MPa
 SC60-32S(W/F) 60dB
 SC60-38S(W/F) 58dB

★SC60-32S(W/F) and SC60-38S(W/F) have same performance; the size of hose and suction pipe are different.

●For fine powder, please use cleaners for fine dust collection.

■ Performance Chart(SC60-32S(W/F) · SC60-38S(W/F))

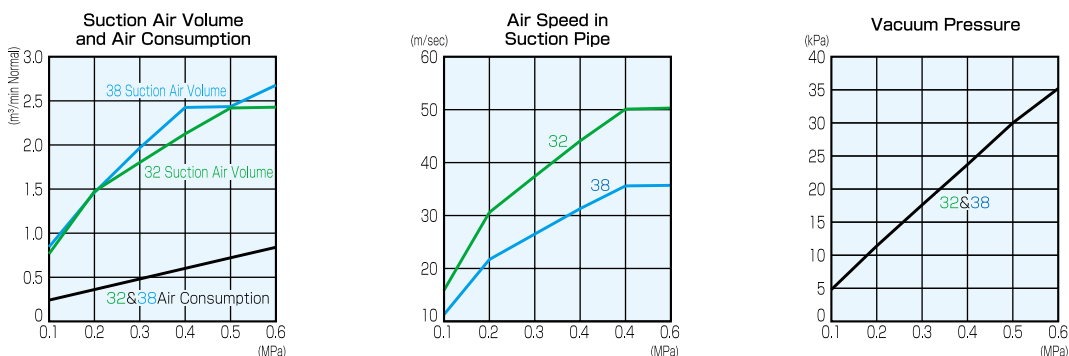

SILENT-CLEANER®

★ SC30-32S (for Dust Collection)
 SC30-32S W/F (for Fine Dust Collection)

● Jet Ejector

Jet Ejector, the heart of the Silent Cleaner, is the device that creates strong suction. There are no rotating parts so no breakdowns.

● Silencer

The silencer keeps exhaust sound low - 60dB with SC30-32S.

● Safety Valve

Safety valve prevents sudden increase of vacuum and breakage of tank, which is caused by air pressure rise or hose obstruction.

● Inner Filter

Inside of Silencer, is glass-wool-made filter. This filter prevents dust from going outside. Please order "fine dust filter" for fine dust.

For Dust Collection;

One filter made of glass wool is equipped. It can be used to collect liquids and solids.

For Fine Dust Collection;

It becomes a double filter of glass wool filter and cloth cover. It can be used for powders recovery.



● For fine powder, please use cleaners for fine dust collection.

■ Performance Chart(SC30-32S(W/F), SC20-32(W/F), SC20-32P(W/F))

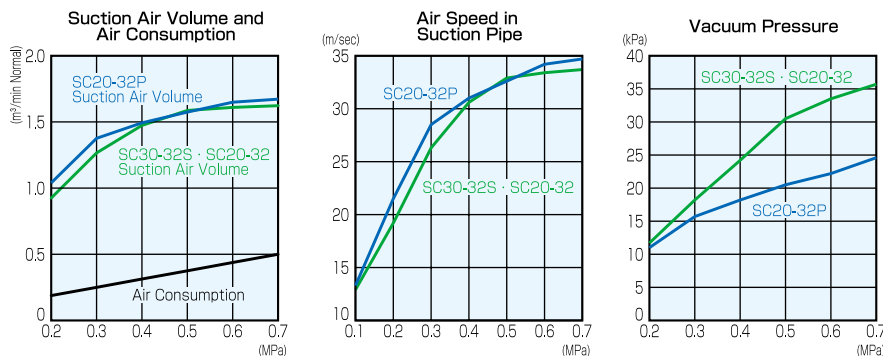

Recommended Compressor Power
 2.2~3.7kw

★ SC20-32 (for Dust Collection)
 SC20-32 W/F (for Fine Dust Collection)



● For fine powder, please use cleaners for fine dust collection.

Easy to Use... Put it on a Tank!!

★ SC20-32P (for Dust Collection)
 SC20-32P W/F (for Fine Dust Collection)

(For 20ℓ Tank)

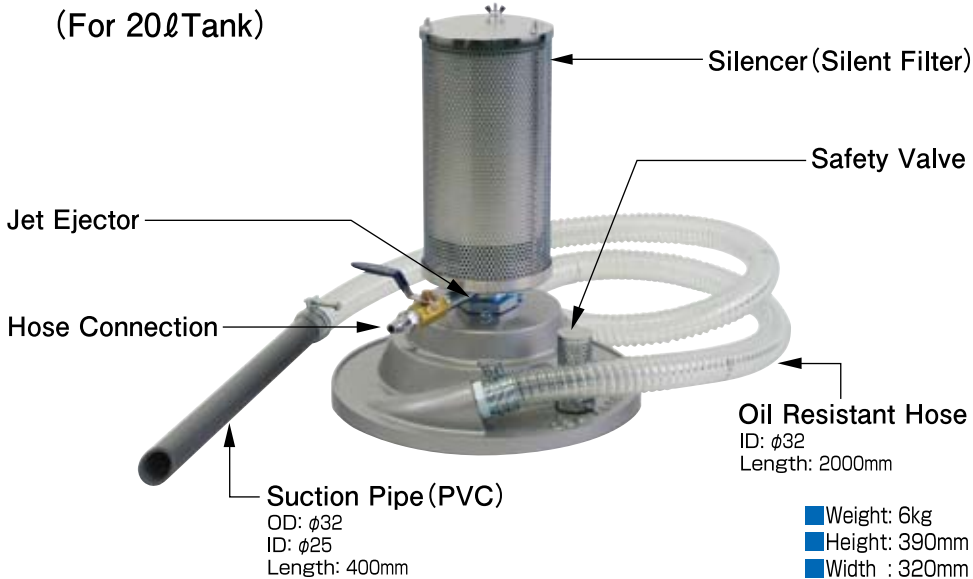

- Please put SC20-32P(W/F) on a 20ℓ Tank. For performance, please refer to performance chart on page(9).
- For fine powder, please use cleaners for fine dust collection.

★ SC200-32D (for Dust Collection) · SC200-38D (for Dust Collection)
 SC200-32D W/F (for Fine Dust Collection) · SC200-38D W/F (for Fine Dust Collection)

(For 200ℓ Open Drum)

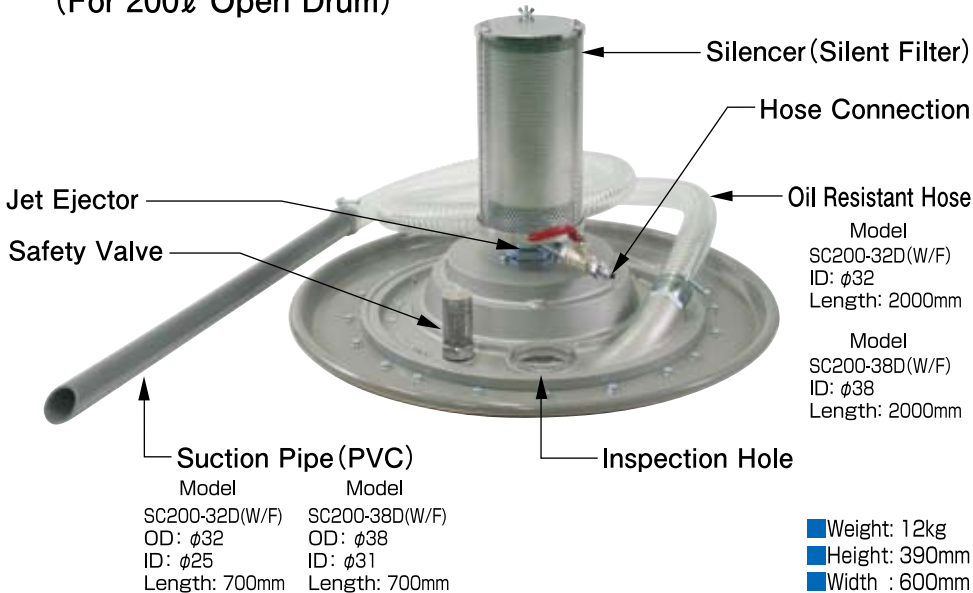

- Please put SC200-32D(W/F) or SC200-38D(W/F) on a 200ℓ open drum. For performance, please refer to performance chart on page(8).
- For fine powder, please use cleaners for fine dust collection.

- We offer powerful versions of Silent Cleaner; ex: SC20-32PG, SC200-32DG.
- We offer Silent Cleaner for fine dust collection.

| | | | |
|-------------|-------------|-------------|--------------|
| SC60-38SW/F | SC60-32SW/F | SC30-32SW/F | SC200-32DW/F |
| SC20-32W/F | SC20-32PW/F | SC60-50SW/F | SC200-38DW/F |

- We recommend attaching Mini Porter Cyclone for a large amount of fine dust or powder.
- We offer Conductive Hose or Antistatic Hose.

Accessories (sold separately)

Fine Dust Filter Cloth Cover



● Fine Dust Filter Set

Please use Fine Filter for fine powder.



● Hydro Stopper

Hydro Stopper stops suction automatically when Silent Cleaner ingests certain amount of liquid.



● Floor Brush



● Round Dusting Brush



● Narrow Nozzle

SILENT-CLEANER®

★ SC60-50S (for Dust Collection)
 SC60-50S W/F (for Fine Dust Collection)

**More POWERFUL
 than other models of
 Silent Cleaner!!**

Powerful!! and SILENT!!

Cleans water, oil, sludge, grains, gravels and metal chips that other existing vacuum cleaners cannot. Recommended for any work place!

★ Built-in Silencer!

★ Two-Ejectors System !

★ Use For hours of operation!



● For fine powder, please use cleaners for fine dust collection.

■ Performance Chart(SC60-50S(W/F))

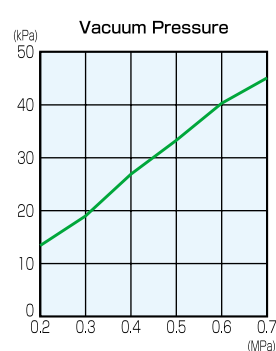
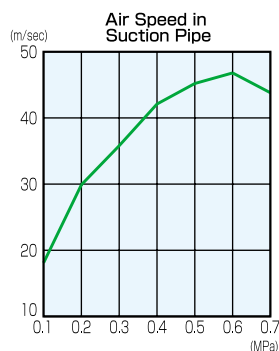
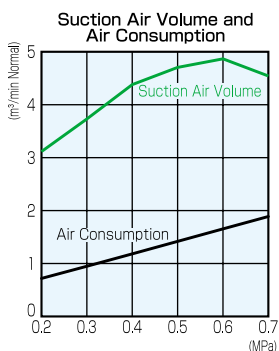

Recommended Compressor Power
 11~15kw

☆ SC30-32TVG (for High Viscosity liquid)

**Vacuum Thick Materials
such as Mayonaise and
Grease EASILY !!**

Powered by Compressor!!

No Rotating Parts -
Breakdowns Caused by Wear and Tear Are
Minimized !!

Grease Model -for High Viscosity liquid

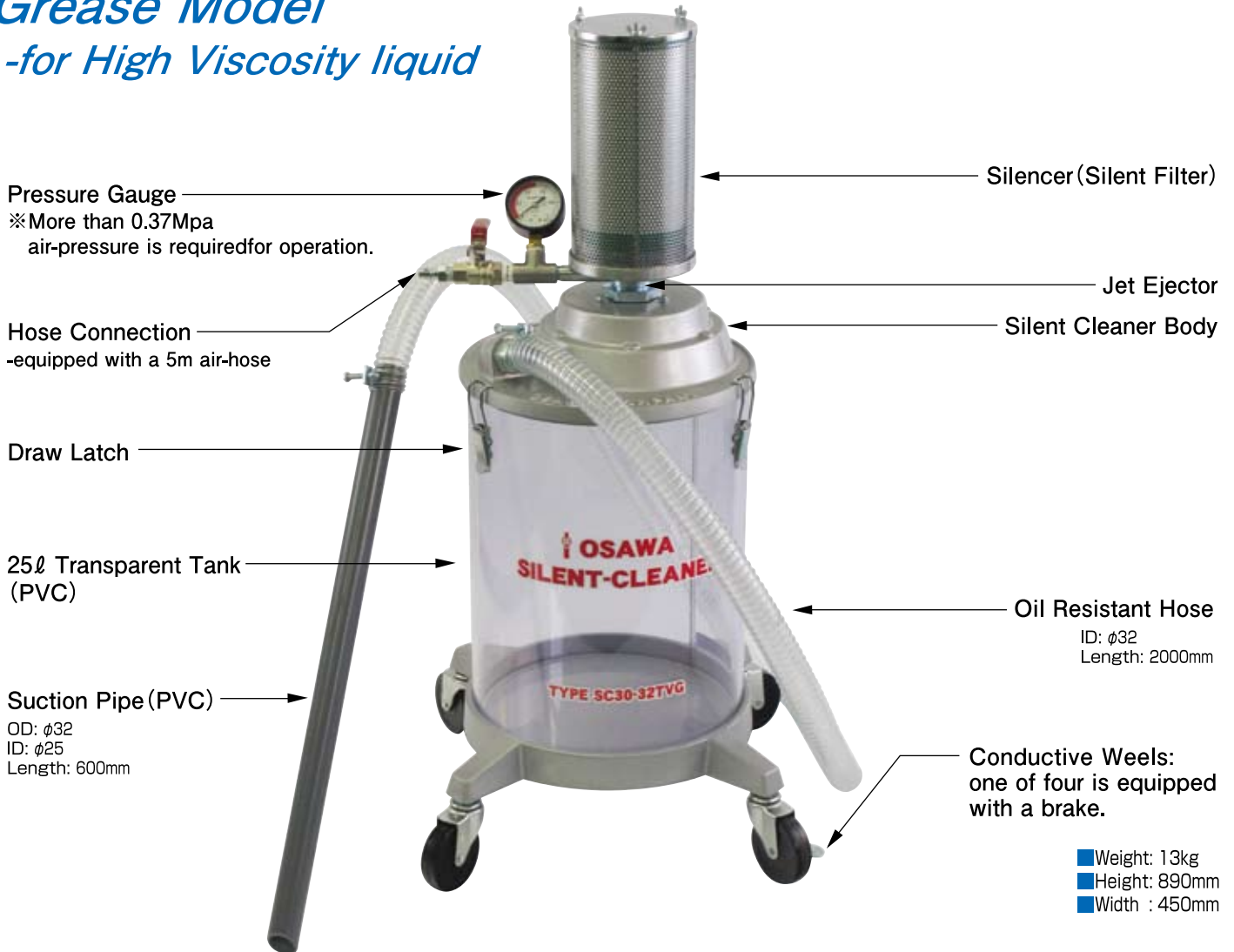

■ Performance Chart(SC30-32TVG·SC3T-19VG)

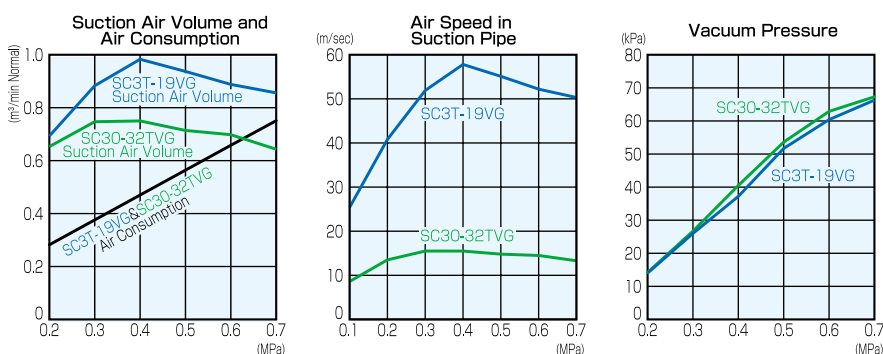

Recommended Compressor Power More than 5.5kw

☆ SC3T-19VG (for High Viscosity liquid)

Equipped with a 5m air-hose

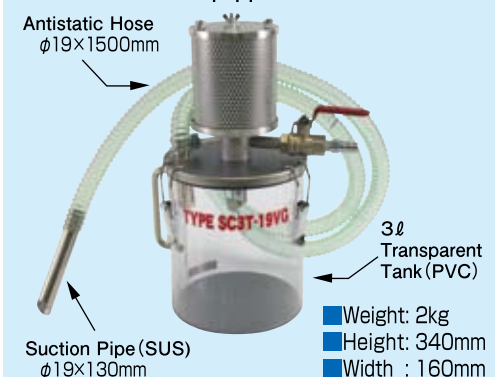

MINI-PORTER-CYCLONE®

MP-38 CF12

No Filters are used to process fine dust or powder.

Can be connected to Any Vacuum Cleaner!!
Easy to Move!!

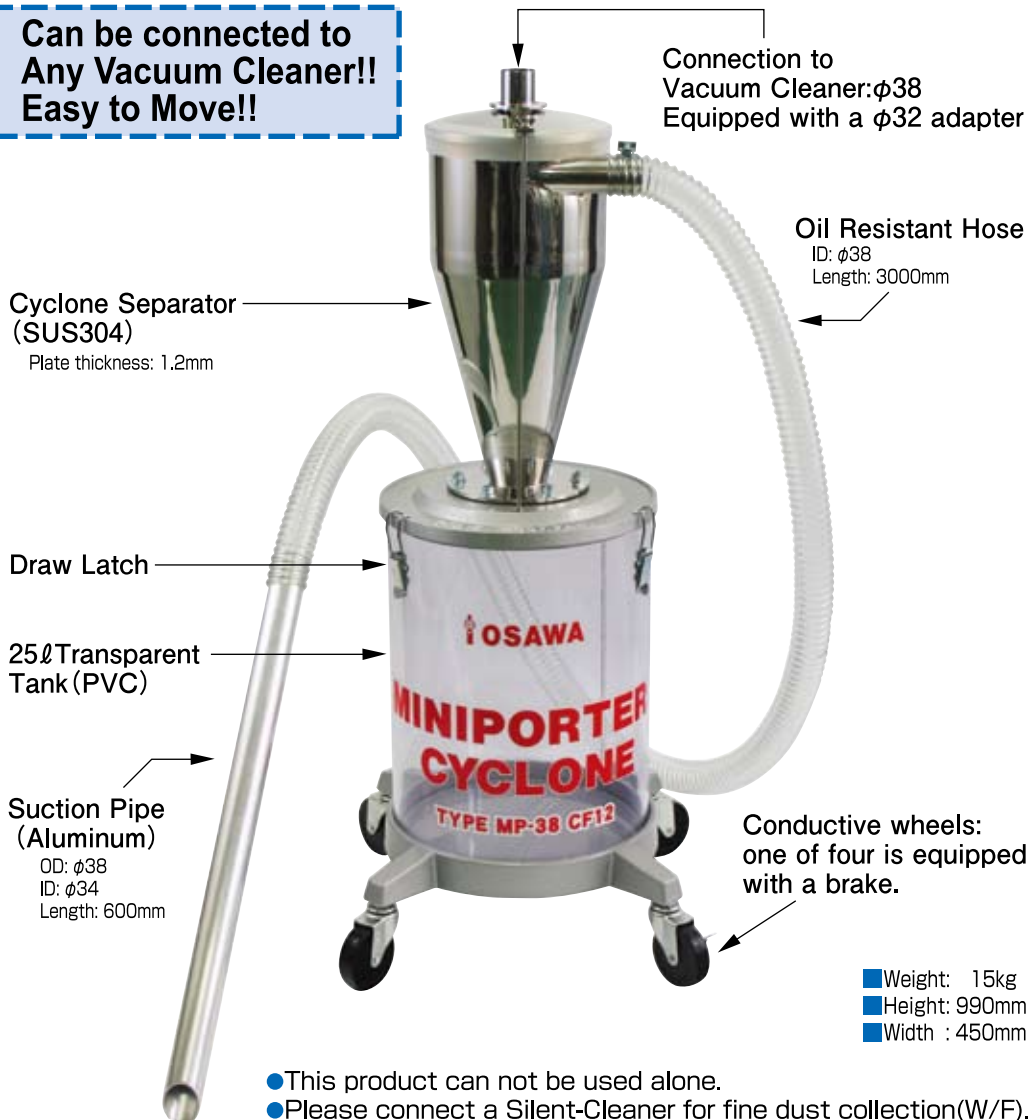

Centrifugal Action of Mini Porter Cyclone

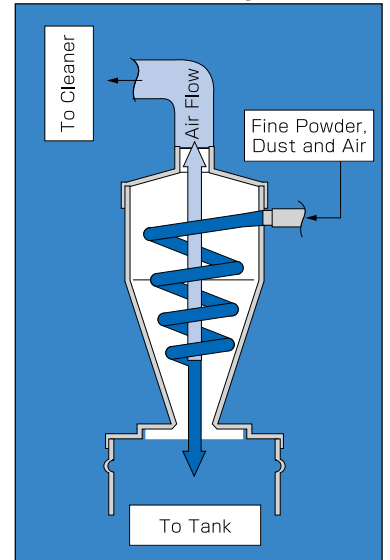

TROUBLES IN HANDLING FINE POWDER??

Mini Porter Cyclone separates powder and air by centrifugal force and sheer dead weight with no filters. Eventually, the powder is dropped into a tank and accumulates while the air flows into the suction machine. When handling flour, for example, the efficiency is almost 100%. This function reduces maintenance and helps to save expense and time.

LIGHT AND COMPACT!!

Great for Cleaning Office Automation Equipment Dust, Toner and stuff.

MP-19

★ SC3T-19

Example of Combination

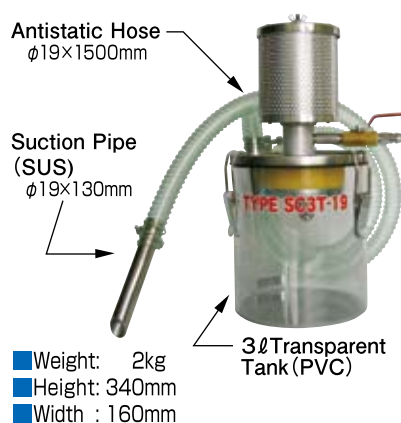
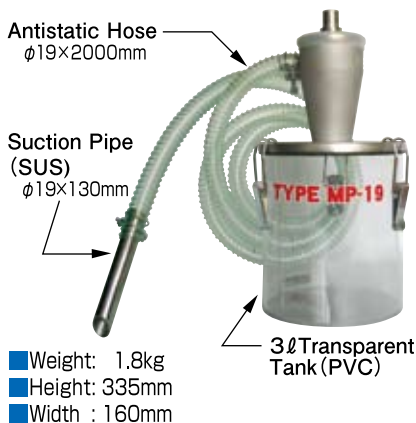

●MP-19: The smallest in the Mini Porter series.
●SC3T-19: The smallest in the Silent Cleaner series
●Please contact us for further details.

★ Combination Model

**Easy to Move!!
Great for
Fine Powder!!**



● For performance, please refer to performance chart on page(9).

★ MP-38WA CF12 with Ejector

**Built-in
Jet Ejector!!**

MP-38WA series are designed specially to handle fine powder.

No Filters are used to process fine dust or powder.

No Rotating parts - Breakdowns caused by wear and tear are minimized.
(Same construction as Silent Cleaner)

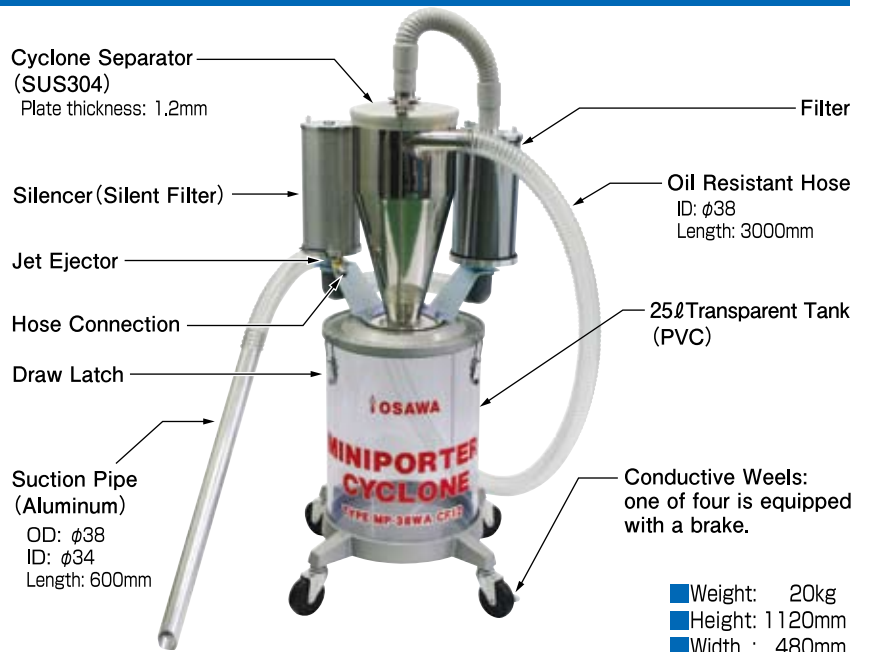

■ Performance Chart(MP-38WA CF12)

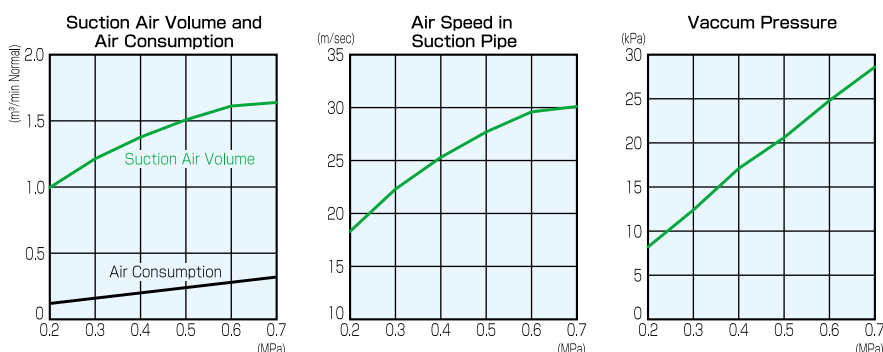

Recommended Compressor Power **2.2kw~3kw**

Mini Porter Cyclone Serie

- MP-38CF12
.....Plate Thickness 1.2mm Hose ID $\phi 38$
- MP-50CF12
.....Plate Thickness 1.2mm Hose ID $\phi 50$
- MP-38WACF12
.....Plate Thickness 1.2mm Hose ID $\phi 38$
- MP-50WACF12
.....Plate Thickness 1.2mm Hose ID $\phi 50$

For custom-orders, please contact us.

■ *Manufactured by*



OSAWA & COMPANY

1-7-28, Yunagi, Minato-ku, Osaka, 552-0004 Japan

TEL: +81-6-6572-1207 FAX: +81-6-6572-1256

<http://www.osawa-company.co.jp>

E-mail: osawa@osawa-company.co.jp

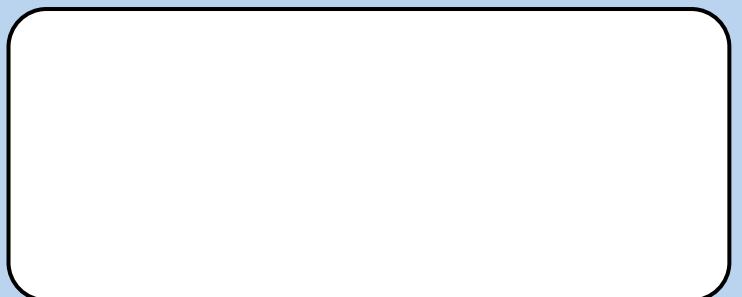

Specifications are subject to change without notice. 2019-01-07-05